

EFL001 MAHINA

Features:

Street, Walkway, Tunnel, Hi-bay and Landscape Lighting. Please contact us on the details below to find out more about our exciting new "Mahina Series" product range.

Weatherproof

Explosion Proof



Warranty:

5 years (Limited 10 Year)

24/7 Commercial Use



Light Distribution Curve

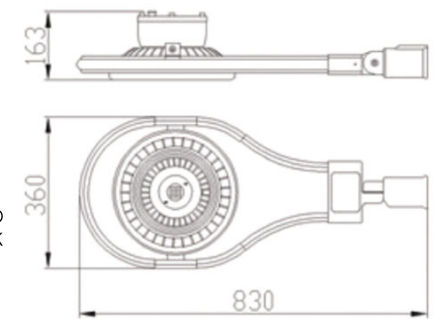
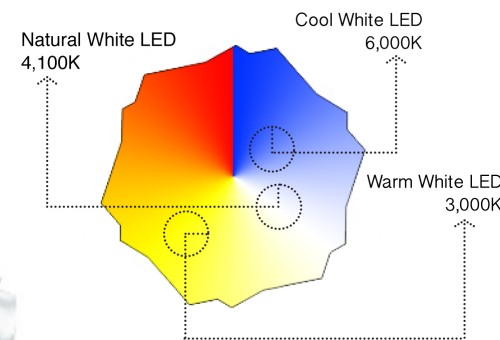
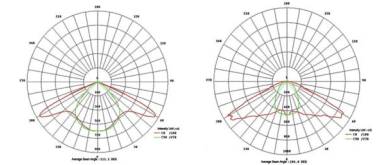

Electrical Optical Characteristics

Model	Beam Angles	Lumens	Watts	Volts	Chip	Color
EFL001-Mahina	90-160°	ww:1585lm · cw4307lm	20-150	85~265v AC	BridgeLux	3,000 - 7,500k

(Lux): Illuminance is a measurement of the light intensity at any point. The light intensity drops exponentially the further you get from the source.

(Lm): The luminous flux is a measure of the total light output from a source. Ex) a 1 candela light source will produce 1 lumen per square meter at the distance of 1 meter.

EFL003 MAHINA

Features:

Street, Walkway, Tunnel, Hi-bay and Landscape Lighting. Please contact us on the details below to find out more about our exciting new "Mahina Series" product range.

Weatherproof

Explosion Proof



Warranty:

5 years (Limited 10 Year)

24/7 Commercial Use

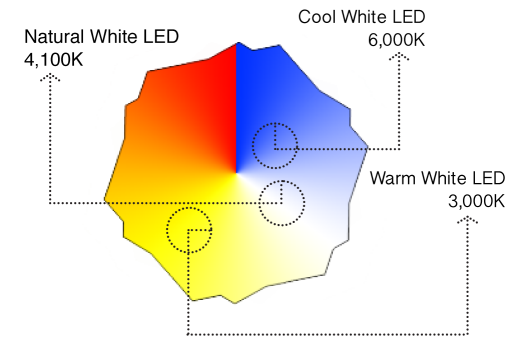

150W Lux data					
LED spotlight			LED streetlight		
Beam Angle 60°		Beam Angle 100°		Beam Angle 125°	
Distance from the light	Illumination	Distance from the light	Illumination	Distance from the light	Illumination
3m	1548	3m	989.4	3m	625.6
6m	482.5	6m	309.25	6m	195.5
8m	272.5	8m	173.75	8m	110
10m	174.25	10m	111.3	10m	70.375
12m	121	12m	76.75	12m	48.75
14m	89	14m	56.75	14m	36
16m	68	16m	43.5	16m	27.5

Electrical Optical Characteristics

Model	Beam Angles	Lumens	Watts	Volts	Chip	Color
EFL003-Mahina	45/52/70/85/95/120	ww:1585lm · cw4307lm	50, 60, 70, 80 90, 100, 120	100~240v AC	BridgeLux	3,000 - 7,500k

(Lux): Illuminance is a measurement of the light intensity at any point. The light intensity drops exponentially the further you get from the source.

(Lm): The luminous flux is a measure of the total light output from a source. Ex) a 1 candela light source will produce 1 lumen per square meter at the distance of 1 meter.

EFL006 MAHINA

Features:

Street, Walkway, Tunnel, Hi-bay and Landscape Lighting. Please contact us on the details below to find out more about our exciting new "Mahina Series" product range.

Weatherproof

Explosion Proof



Warranty:
5 years (Limited 10 Year)

24/7 Commercial Use

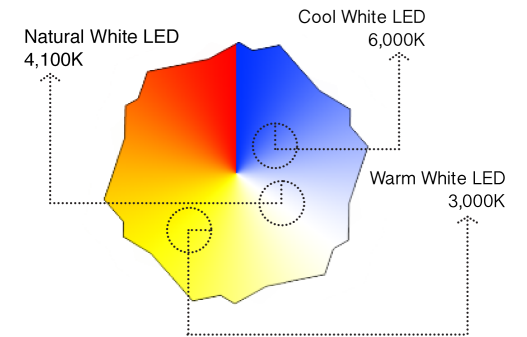

150W Lux data					
LED spotlight			LED streetlight		
Beam Angle 60°		Beam Angle 100°		Beam Angle 125°	
Distance from the light	Illumination	Distance from the light	Illumination	Distance from the light	Illumination
3m	1548	3m	989.4	3m	625.6
6m	482.5	6m	309.25	6m	195.5
8m	272.5	8m	173.75	8m	110
10m	174.25	10m	111.3	10m	70.375
12m	121	12m	76.75	12m	48.75
14m	89	14m	56.75	14m	36
16m	68	16m	43.5	16m	27.5

Electrical Optical Characteristics

Model	Beam Angles	Lumens	Watts	Volts	Chip	Color
EFL006-Mahina	45/52/70/85/95/120	ww:1585lm · cw4307lm	50, 60, 70, 80 90, 100, 120	100~240v AC	BridgeLux	3,000 - 7,500k

(Lux): Illuminance is a measurement of the light intensity at any point. The light intensity drops exponentially the further you get from the source.

(Lm): The luminous flux is a measure of the total light output from a source. Ex) a 1 candela light source will produce 1 lumen per square meter at the distance of 1 meter.

EFL007 MAHINA

Features:

Street, Walkway, Tunnel, Hi-bay and Landscape Lighting. Please contact us on the details below to find out more about our exciting new "Mahina Series" product range.

Weatherproof

Explosion Proof



Warranty:
5 years (Limited 10 Year)

24/7 Commercial Use

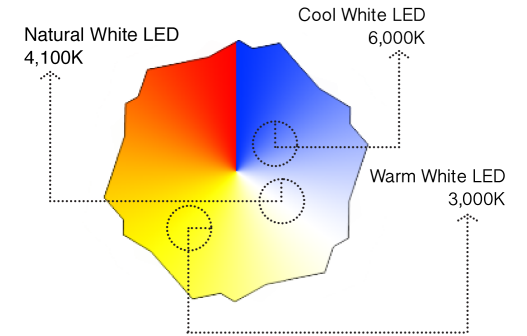

150W Lux data					
LED spotlight			LED streetlight		
Beam Angle 60°		Beam Angle 100°		Beam Angle 125°	
Distance from the light	Illumination	Distance from the light	Illumination	Distance from the light	Illumination
3m	1548	3m	989.4	3m	625.6
6m	482.5	6m	309.25	6m	195.5
8m	272.5	8m	173.75	8m	110
10m	174.25	10m	111.3	10m	70.375
12m	121	12m	76.75	12m	48.75
14m	89	14m	56.75	14m	36
16m	68	16m	43.5	16m	27.5

Electrical Optical Characteristics

Model	Beam Angles	Lumens	Watts	Volts	Chip	Color
EFL007-Mahina	45/52/70/85/95/120	ww:1585lm · cw4307lm	50, 60, 70, 80 90, 100, 120	100~240v AC	BridgeLux	3,000 - 7,500k

(Lux): Illuminance is a measurement of the light intensity at any point. The light intensity drops exponentially the further you get from the source.

(Lm): The luminous flux is a measure of the total light output from a source. Ex) a 1 candela light source will produce 1 lumen per square meter at the distance of 1 meter.

EFL008 MAHINA

Features:

Street, Walkway, Tunnel, Hi-bay and Landscape Lighting. Please contact us on the details below to find out more about our exciting new "Mahina Series" product range.

Weatherproof

Explosion Proof



Warranty:

5 years (Limited 10 Year)

24/7 Commercial Use

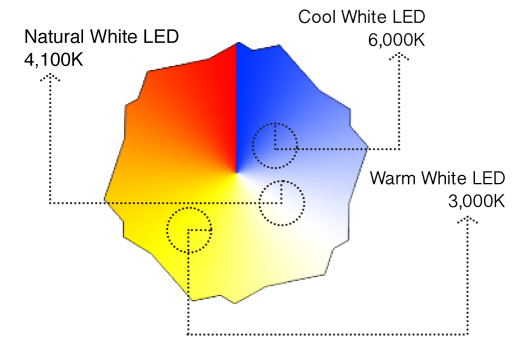

150W Lux data					
LED spotlight				LED streetlight	
Beam Angle 60°		Beam Angle 100°		Beam Angle 125°	
Distance from the light	Illumination	Distance from the light	Illumination	Distance from the light	Illumination
3m	1548	3m	989.4	3m	625.6
6m	482.5	6m	309.25	6m	195.5
8m	272.5	8m	173.75	8m	110
10m	174.25	10m	111.3	10m	70.375
12m	121	12m	76.75	12m	48.75
14m	89	14m	56.75	14m	36
16m	68	16m	43.5	16m	27.5

Electrical Optical Characteristics

Model	Beam Angles	Lumens	Watts	Volts	Chip	Color
EFL008-Mahina	45/52/70/85/95/120	ww:1585lm · cw4307lm	50, 60, 70, 80 90, 100, 120	100~240v AC	BridgeLux	3,000 - 7,500k

(Lux): Illuminance is a measurement of the light intensity at any point. The light intensity drops exponentially the further you get from the source.

(Lm): The luminous flux is a measure of the total light output from a source. Ex) a 1 candela light source will produce 1 lumen per square meter at the distance of 1 meter.

EFL009 MAHINA

Features:

Street, Walkway, Tunnel, Hi-bay and Landscape Lighting. Please contact us on the details below to find out more about our exciting new "Mahina Series" product range.

Weatherproof

Explosion Proof



Warranty:

5 years (Limited 10 Year)

24/7 Commercial Use

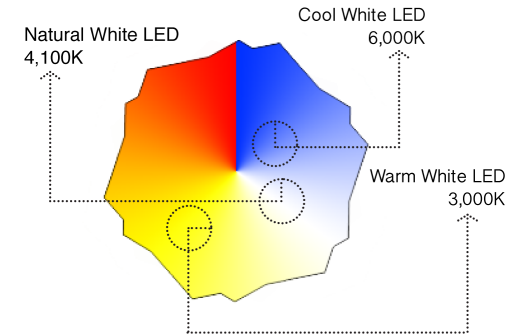

150W Lux data					
LED spotlight			LED streetlight		
Beam Angle 60°		Beam Angle 100°		Beam Angle 125°	
Distance from the light	Illumination	Distance from the light	Illumination	Distance from the light	Illumination
3m	1548	3m	989.4	3m	625.6
6m	482.5	6m	309.25	6m	195.5
8m	272.5	8m	173.75	8m	110
10m	174.25	10m	111.3	10m	70.375
12m	121	12m	76.75	12m	48.75
14m	89	14m	56.75	14m	36
16m	68	16m	43.5	16m	27.5

Electrical Optical Characteristics

Model	Beam Angles	Lumens	Watts	Volts	Chip	Color
EFL009-Mahina	45/52/70/85/95/120	ww:1585lm · cw4307lm	50, 60, 70, 80 90, 100, 120	100~240v AC	BridgeLux	3,000 - 7,500k

(Lux): Illuminance is a measurement of the light intensity at any point. The light intensity drops exponentially the further you get from the source.

(Lm): The luminous flux is a measure of the total light output from a source. Ex) a 1 candela light source will produce 1 lumen per square meter at the distance of 1 meter.

EFL010 MAHINA

Features:

Street, Walkway, Tunnel, Hi-bay and Landscape Lighting. Please contact us on the details below to find out more about our exciting new "Mahina Series" product range.

Weatherproof

Explosion Proof



Warranty:
5 years (Limited 10 Year)

24/7 Commercial Use

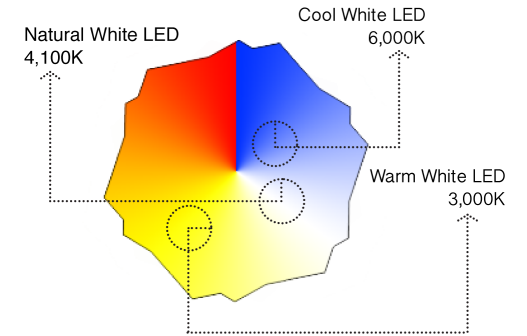

150W Lux data					
LED spotlight				LED streetlight	
Beam Angle 60°		Beam Angle 100°		Beam Angle 125°	
Distance from the light	Illumination	Distance from the light	Illumination	Distance from the light	Illumination
3m	1548	3m	989.4	3m	625.6
6m	482.5	6m	309.25	6m	195.5
8m	272.5	8m	173.75	8m	110
10m	174.25	10m	111.3	10m	70.375
12m	121	12m	76.75	12m	48.75
14m	89	14m	56.75	14m	36
16m	68	16m	43.5	16m	27.5

Electrical Optical Characteristics

Model	Beam Angles	Lumens	Watts	Volts	Chip	Color
EFL010-Mahina	45/52/70/85/95/120	ww:1585lm · cw4307lm	50, 60, 70, 80 90, 100, 120	100~240v AC	BridgeLux	3,000 - 7,500k

(Lux): Illuminance is a measurement of the light intensity at any point. The light intensity drops exponentially the further you get from the source.

(Lm): The luminous flux is a measure of the total light output from a source. Ex) a 1 candela light source will produce 1 lumen per square meter at the distance of 1 meter.

EFL012 MAHINA

Features:

Street, Walkway, Tunnel, Hi-bay and Landscape Lighting. Please contact us on the details below to find out more about our exciting new "Mahina Series" product range.

Weatherproof

Explosion Proof



Warranty:
5 years (Limited 10 Year)

24/7 Commercial Use

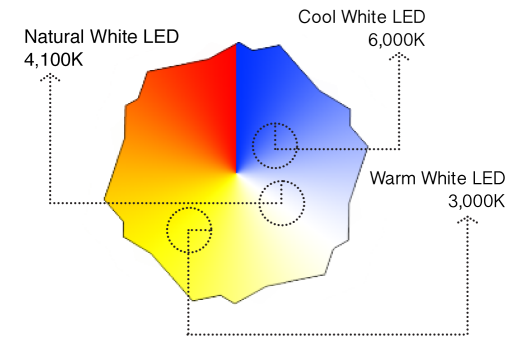

150W Lux data					
LED spotlight			LED streetlight		
Beam Angle 60°		Beam Angle 100°		Beam Angle 125°	
Distance from the light	Illumination	Distance from the light	Illumination	Distance from the light	Illumination
3m	1548	3m	989.4	3m	625.6
6m	482.5	6m	309.25	6m	195.5
8m	272.5	8m	173.75	8m	110
10m	174.25	10m	111.3	10m	70.375
12m	121	12m	76.75	12m	48.75
14m	89	14m	56.75	14m	36
16m	68	16m	43.5	16m	27.5

Electrical Optical Characteristics

Model	Beam Angles	Lumens	Watts	Volts	Chip	Color
EFL012-Mahina	45/52/70/85/95/120	ww:1585lm · cw4307lm	50, 60, 70, 80 90, 100, 120	100~240v AC	BridgeLux	3,000 - 7,500k

(Lux): Illuminance is a measurement of the light intensity at any point. The light intensity drops exponentially the further you get from the source.

(Lm): The luminous flux is a measure of the total light output from a source. Ex) a 1 candela light source will produce 1 lumen per square meter at the distance of 1 meter.

EFL015 MAHINA

Features:

Street, Walkway, Tunnel, Hi-bay and Landscape Lighting. Please contact us on the details below to find out more about our exciting new "Mahina Series" product range.

Weatherproof

Explosion Proof



Warranty:

5 years (Limited 10 Year)

24/7 Commercial Use



Light Distribution Curve

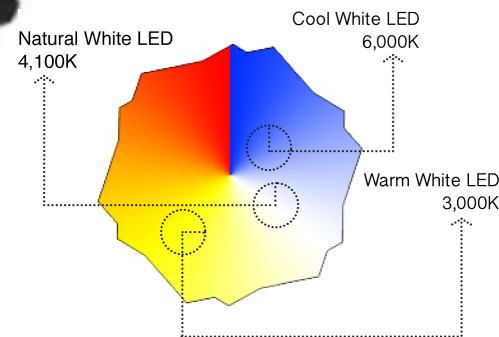
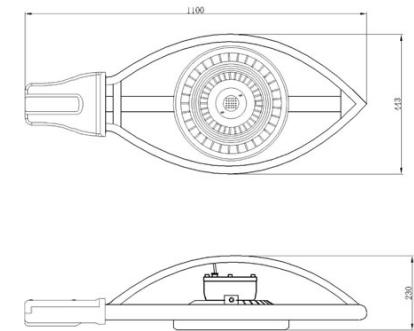
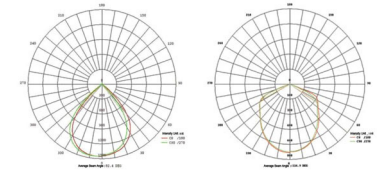

Electrical Optical Characteristics

Model	Beam Angles	Lumens	Watts	Volts	Chip	Color
EFL015-Mahina	45/52/70/85/95/120	ww:1585lm · cw4307lm	50, 60, 70, 80 90, 100, 120	100~240v AC	BridgeLux	3,000 - 7,500k

(Lux): Illuminance is a measurement of the light intensity at any point. The light intensity drops exponentially the further you get from the source.

(Lm): The luminous flux is a measure of the total light output from a source. Ex) a 1 candela light source will produce 1 lumen per square meter at the distance of 1 meter.

EFL016 MAHINA

Features:

Street, Walkway, Tunnel, Hi-bay and Landscape Lighting. Please contact us on the details below to find out more about our exciting new "Mahina Series" product range.

Weatherproof

Explosion Proof



Warranty:
5 years (Limited 10 Year)

24/7 Commercial Use

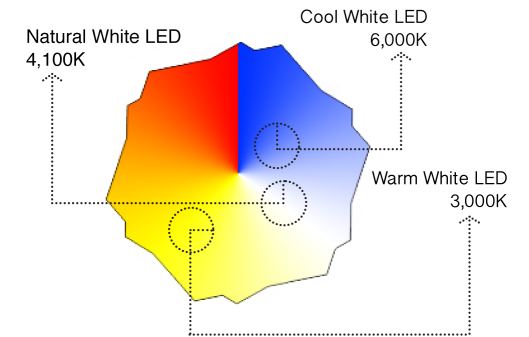

150W Lux data					
LED spotlight			LED streetlight		
Beam Angle 60°		Beam Angle 100°		Beam Angle 125°	
Distance from the light	Illumination	Distance from the light	Illumination	Distance from the light	Illumination
3m	1548	3m	989.4	3m	625.6
6m	482.5	6m	309.25	6m	195.5
8m	272.5	8m	173.75	8m	110
10m	174.25	10m	111.3	10m	70.375
12m	121	12m	76.75	12m	48.75
14m	89	14m	56.75	14m	36
16m	68	16m	43.5	16m	27.5

Electrical Optical Characteristics

Model	Beam Angles	Lumens	Watts	Volts	Chip	Color
EFL016-Mahina	45/52/70/85/95/120	ww:1585lm · cw4307lm	50, 60, 70, 80 90, 100, 120	100~240v AC	BridgeLux	3,000 - 7,500k

(Lux): Illuminance is a measurement of the light intensity at any point. The light intensity drops exponentially the further you get from the source.

(Lm): The luminous flux is a measure of the total light output from a source. Ex) a 1 candela light source will produce 1 lumen per square meter at the distance of 1 meter.



EFL017 MAHINA

Features:

Street, Walkway, Tunnel, Hi-bay and Landscape Lighting. Please contact us on the details below to find out more about our exciting new "Mahina Series" product range.

Weatherproof

Explosion Proof



Warranty:
5 years (Limited 10 Year)

24/7 Commercial Use

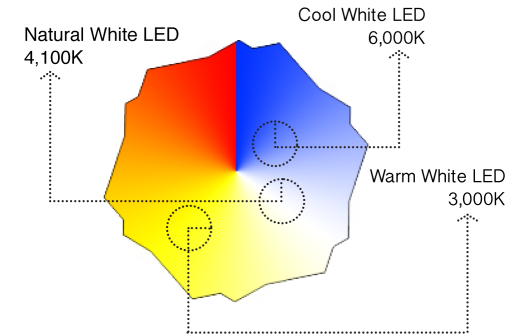

150W Lux data					
LED spotlight				LED streetlight	
Beam Angle 60°		Beam Angle 100°		Beam Angle 125°	
Distance from the light	Illumination	Distance from the light	Illumination	Distance from the light	Illumination
3m	1548	3m	989.4	3m	625.6
6m	482.5	6m	309.25	6m	195.5
8m	272.5	8m	173.75	8m	110
10m	174.25	10m	111.3	10m	70.375
12m	121	12m	76.75	12m	48.75
14m	89	14m	56.75	14m	36
16m	68	16m	43.5	16m	27.5

Electrical Optical Characteristics

Model	Beam Angles	Lumens	Watts	Volts	Chip	Color
EFL017-Mahina	45/52/70/85/95/120	ww:1585lm · cw4307lm	50, 60, 70, 80 90, 100, 120	100~240v AC	BridgeLux	3,000 - 7,500k

(Lux): Illuminance is a measurement of the light intensity at any point. The light intensity drops exponentially the further you get from the source.

(Lm): The luminous flux is a measure of the total light output from a source. Ex) a 1 candela light source will produce 1 lumen per square meter at the distance of 1 meter.

EFL018 MAHINA

Features:

Street, Walkway, Tunnel, Hi-bay and Landscape Lighting. Please contact us on the details below to find out more about our exciting new "Mahina Series" product range.

Weatherproof

Explosion Proof



Warranty:

5 years (Limited 10 Year)

24/7 Commercial Use



Light Distribution Curve

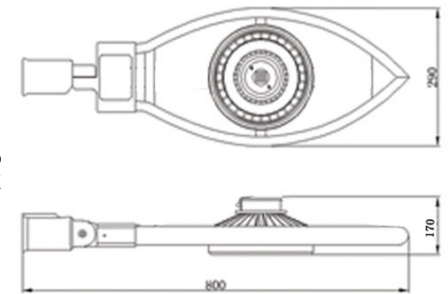
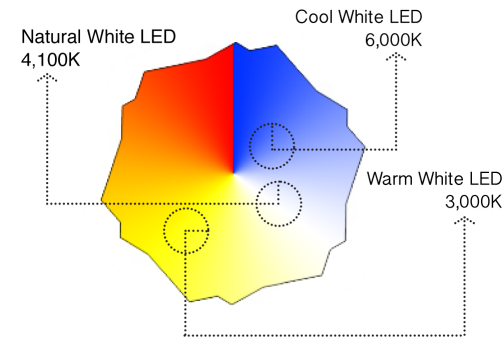
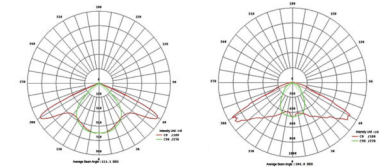

Electrical Optical Characteristics

Model	Beam Angles	Lumens	Watts	Volts	Chip	Color
EFL018-Mahina	45/52/70/85/95/120	ww:1585lm · cw4307lm	50, 60, 70, 80 90, 100, 120	100~240v AC	BridgeLux	3,000 - 7,500k

(Lux): Illuminance is a measurement of the light intensity at any point. The light intensity drops exponentially the further you get from the source.

(Lm): The luminous flux is a measure of the total light output from a source. Ex) a 1 candela light source will produce 1 lumen per square meter at the distance of 1 meter.

EFL019 MAHINA

Features:

Street, Walkway, Tunnel, Hi-bay and Landscape Lighting. Please contact us on the details below to find out more about our exciting new "Mahina Series" product range.

Weatherproof

Explosion Proof



Warranty:
5 years (Limited 10 Year)

24/7 Commercial Use

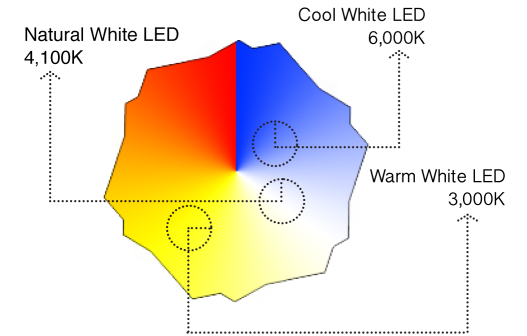

150W Lux data					
LED spotlight			LED streetlight		
Beam Angle 60°		Beam Angle 100°		Beam Angle 125°	
Distance from the light	Illumination	Distance from the light	Illumination	Distance from the light	Illumination
3m	1548	3m	989.4	3m	625.6
6m	482.5	6m	309.25	6m	195.5
8m	272.5	8m	173.75	8m	110
10m	174.25	10m	111.3	10m	70.375
12m	121	12m	76.75	12m	48.75
14m	89	14m	56.75	14m	36
16m	68	16m	43.5	16m	27.5

Electrical Optical Characteristics

Model	Beam Angles	Lumens	Watts	Volts	Chip	Color
EFL019-Mahina	45/52/70/85/95/120	ww:1585lm · cw4307lm	50, 60, 70, 80 90, 100, 120	100~240v AC	BridgeLux	3,000 - 7,500k

(Lux): Illuminance is a measurement of the light intensity at any point. The light intensity drops exponentially the further you get from the source.

(Lm): The luminous flux is a measure of the total light output from a source. Ex) a 1 candela light source will produce 1 lumen per square meter at the distance of 1 meter.

EFL022 MAHINA

Features:

Street, Walkway, Tunnel, Hi-bay and Landscape Lighting. Please contact us on the details below to find out more about our exciting new "Mahina Series" product range.

Weatherproof

Explosion Proof



Warranty:
5 years (Limited 10 Year)

24/7 Commercial Use

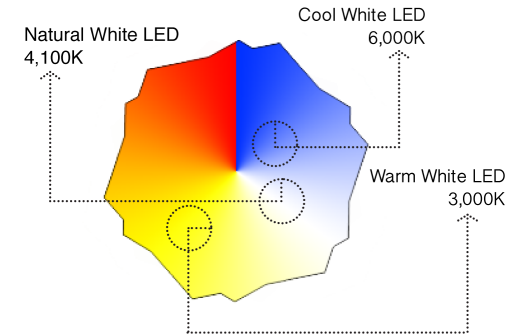

150W Lux data					
LED spotlight			LED streetlight		
Beam Angle 60°		Beam Angle 100°		Beam Angle 125°	
Distance from the light	Illumination	Distance from the light	Illumination	Distance from the light	Illumination
3m	1548	3m	989.4	3m	625.6
6m	482.5	6m	309.25	6m	195.5
8m	272.5	8m	173.75	8m	110
10m	174.25	10m	111.3	10m	70.375
12m	121	12m	76.75	12m	48.75
14m	89	14m	56.75	14m	36
16m	68	16m	43.5	16m	27.5

Electrical Optical Characteristics

Model	Beam Angles	Lumens	Watts	Volts	Chip	Color
EFL022-Mahina	60/85/120	ww:1078lm · cw1542lm	20, 30, 40	100~240v AC	BridgeLux	3,000 - 7,500k

(Lux): Illuminance is a measurement of the light intensity at any point. The light intensity drops exponentially the further you get from the source.

(Lm): The luminous flux is a measure of the total light output from a source. Ex) a 1 candela light source will produce 1 lumen per square meter at the distance of 1 meter.

EFL025 MAHINA

Features:

Street, Walkway, Tunnel, Hi-bay and Landscape Lighting. Please contact us on the details below to find out more about our exciting new "Mahina Series" product range.

Weatherproof and Explosion Proof



Warranty:
5 years (Limited 10 Year)

24/7 Commercial Use

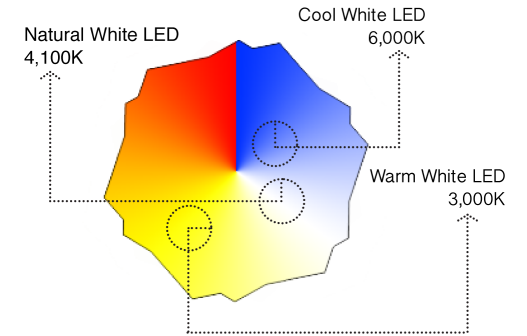

150W Lux data

LED spotlight		LED streetlight			
Beam Angle 60°		Beam Angle 100°		Beam Angle 125°	
Distance from the light	Illumination	Distance from the light	Illumination	Distance from the light	Illumination
3m	1548	3m	989.4	3m	625.6
6m	482.5	6m	309.25	6m	195.5
8m	272.5	8m	173.75	8m	110
10m	174.25	10m	111.3	10m	70.375
12m	121	12m	76.75	12m	48.75
14m	89	14m	56.75	14m	36
16m	68	16m	43.5	16m	27.5

Electrical Optical Characteristics

Model	Beam Angles	Lumens	Watts	Volts	Chip	Color
EFL025-Mahina	60/80/120	ww:1078lm · cw1542lm	20,30, 40, 45, 50, 52, 70, 85, 95, 120	100~240v AC	BridgeLux	3,000 - 7,500k

(Lux): Illuminance is a measurement of the light intensity at any point. The light intensity drops exponentially the further you get from the source.

(Lm): The luminous flux is a measure of the total light output from a source. Ex) a 1 candela light source will produce 1 lumen per square meter at the distance of 1 meter.

EFL028 MAHINA

Features:

Street, Walkway, Tunnel, Hi-bay and Landscape Lighting. Please contact us on the details below to find out more about our exciting new "Mahina Series" product range.

Weatherproof and Explosion Proof



Warranty:
5 years (Limited 10 Year)

24/7 Commercial Use

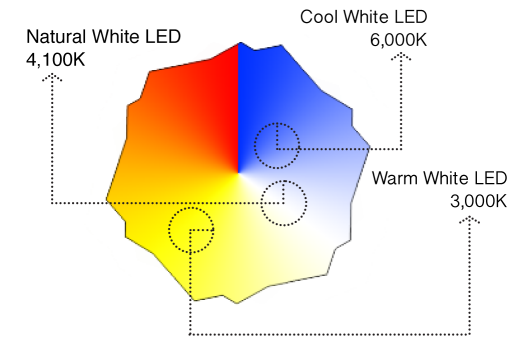

150W Lux data					
LED spotlight			LED streetlight		
Beam Angle 60°		Beam Angle 100°		Beam Angle 125°	
Distance from the light	Illumination	Distance from the light	Illumination	Distance from the light	Illumination
3m	1548	3m	989.4	3m	625.6
6m	482.5	6m	309.25	6m	195.5
8m	272.5	8m	173.75	8m	110
10m	174.25	10m	111.3	10m	70.375
12m	121	12m	76.75	12m	48.75
14m	89	14m	56.75	14m	36
16m	68	16m	43.5	16m	27.5

Electrical Optical Characteristics

Model	Beam Angles	Lumens	Watts	Volts	Chip	Color
EFL028-Mahina	45/52/70/85/95/120	ww:1585lm · cw4307lm	50, 60, 70, 80 90, 100, 120	100~240v AC	BridgeLux	3,000 - 7,500k

(Lux): Illuminance is a measurement of the light intensity at any point. The light intensity drops exponentially the further you get from the source.

(Lm): The luminous flux is a measure of the total light output from a source. Ex) a 1 candela light source will produce 1 lumen per square meter at the distance of 1 meter.

EFL029 COBRA

Features:

Street, Walkway, Tunnel, Hi-bay and Landscape Lighting. Please contact us on the details below to find out more about our exciting new "Mahina Series" product range.

Weatherproof and Explosion Proof



Warranty:

5 years (Limited 10 Year)

24/7 Commercial Use

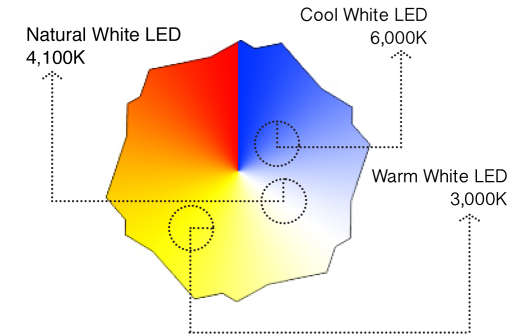

150W Lux data					
LED spotlight			LED streetlight		
Beam Angle 60°		Beam Angle 100°		Beam Angle 125°	
Distance from the light	Illumination	Distance from the light	Illumination	Distance from the light	Illumination
3m	1548	3m	989.4	3m	625.6
6m	482.5	6m	309.25	6m	195.5
8m	272.5	8m	173.75	8m	110
10m	174.25	10m	111.3	10m	70.375
12m	121	12m	76.75	12m	48.75
14m	89	14m	56.75	14m	36
16m	68	16m	43.5	16m	27.5

Electrical Optical Characteristics

Model	Beam Angles	Lumens	Watts	Volts	Chip	Color
EFL029-Cobra	45/52/70/85/95/120	ww:1585lm · cw4307lm	50, 60, 70, 80 90, 100, 120	100~240v AC	BridgeLux	3,000 - 7,500k

(Lux): Illuminance is a measurement of the light intensity at any point. The light intensity drops exponentially the further you get from the source.

(Lm): The luminous flux is a measure of the total light output from a source. Ex) a 1 candela light source will produce 1 lumen per square meter at the distance of 1 meter.

EFL030 COBRA

Features:

Street, Walkway, Tunnel, Hi-bay and Landscape Lighting. Please contact us on the details below to find out more about our exciting new "Mahina Series" product range.

Weatherproof

Explosion Proof



Warranty:

5 years (Limited 10 Year)

24/7 Commercial Use

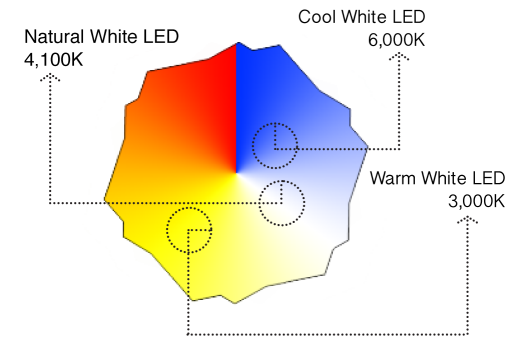

150W Lux data					
LED spotlight			LED streetlight		
Beam Angle 60°		Beam Angle 100°		Beam Angle 125°	
Distance from the light	Illumination	Distance from the light	Illumination	Distance from the light	Illumination
3m	1548	3m	989.4	3m	625.6
6m	482.5	6m	309.25	6m	195.5
8m	272.5	8m	173.75	8m	110
10m	174.25	10m	111.3	10m	70.375
12m	121	12m	76.75	12m	48.75
14m	89	14m	56.75	14m	36
16m	68	16m	43.5	16m	27.5

Electrical Optical Characteristics

Model	Beam Angles	Lumens	Watts	Volts	Chip	Color
EFL030-Cobra	45/52/70/85/95/120	ww:1585lm · cw4307lm	50, 60, 70, 80 90, 100, 120	100~240v AC	BridgeLux	3,000 - 7,500k

(Lux): Illuminance is a measurement of the light intensity at any point. The light intensity drops exponentially the further you get from the source.

(Lm): The luminous flux is a measure of the total light output from a source. Ex) a 1 candela light source will produce 1 lumen per square meter at the distance of 1 meter.

EFL031 COBRA II

Features:

Street, Walkway, Tunnel, Hi-bay and Landscape Lighting. Please contact us on the details below to find out more about our exciting new "Mahina Series" product range.

Weatherproof

Explosion Proof



Warranty:

5 years (Limited 10 Year)

24/7 Commercial Use

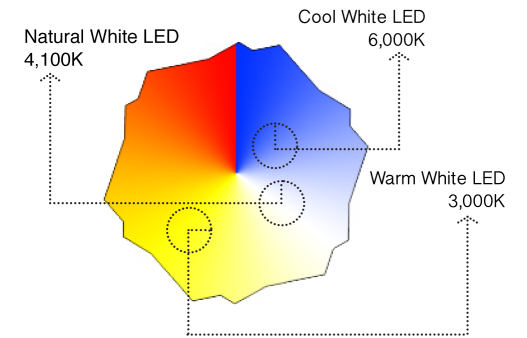

150W Lux data					
LED spotlight			LED streetlight		
Beam Angle 60°		Beam Angle 100°		Beam Angle 125°	
Distance from the light	Illumination	Distance from the light	Illumination	Distance from the light	Illumination
3m	1548	3m	989.4	3m	625.6
6m	482.5	6m	309.25	6m	195.5
8m	272.5	8m	173.75	8m	110
10m	174.25	10m	111.3	10m	70.375
12m	121	12m	76.75	12m	48.75
14m	89	14m	56.75	14m	36
16m	68	16m	43.5	16m	27.5

Electrical Optical Characteristics

Model	Beam Angles	Lumens	Watts	Volts	Chip	Color
EFL031-Cobra II	45/52/70/85/95/120	ww:1585lm · cw4307lm	50, 60, 70, 80 90, 100, 120	100~240v AC	BridgeLux	3,000 - 7,500k

(Lux): Illuminance is a measurement of the light intensity at any point. The light intensity drops exponentially the further you get from the source.

(Lm): The luminous flux is a measure of the total light output from a source. Ex) a 1 candela light source will produce 1 lumen per square meter at the distance of 1 meter.

EFLT-03 MAHINA

Features:

Street, Walkway, Tunnel, Hi-bay and Landscape Lighting. Please contact us on the details below to find out more about our exciting new "Mahina Series" product range.

Weatherproof

Explosion Proof



Warranty:

5 years (Limited 10 Year)

24/7 Commercial Use

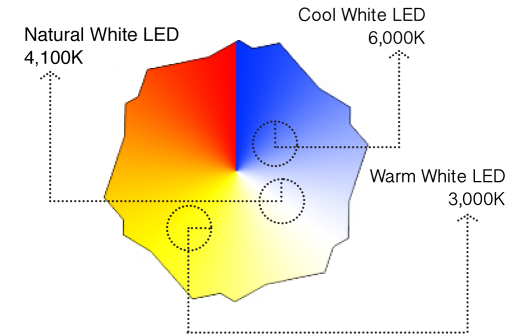

150W Lux data					
LED spotlight			LED streetlight		
Beam Angle 60°		Beam Angle 100°		Beam Angle 125°	
Distance from the light	Illumination	Distance from the light	Illumination	Distance from the light	Illumination
3m	1548	3m	989.4	3m	625.6
6m	482.5	6m	309.25	6m	195.5
8m	272.5	8m	173.75	8m	110
10m	174.25	10m	111.3	10m	70.375
12m	121	12m	76.75	12m	48.75
14m	89	14m	56.75	14m	36
16m	68	16m	43.5	16m	27.5

Electrical Optical Characteristics

Model	Beam Angles	Lumens	Watts	Volts	Chip	Color
EFLT-03-Mahina	90 -140°	ww:1585lm · cw4307lm	50 - 60	85~265v AC / 12~48 DC	BridgeLux	3,000 - 7,500k

(Lux): Illuminance is a measurement of the light intensity at any point. The light intensity drops exponentially the further you get from the source.

(Lm): The luminous flux is a measure of the total light output from a source. Ex) a 1 candela light source will produce 1 lumen per square meter at the distance of 1 meter.

EFLT-04 MAHINA

Features:

Street, Walkway, Tunnel, Hi-bay and Landscape Lighting. Please contact us on the details below to find out more about our exciting new "Mahina Series" product range.

Weatherproof

Explosion Proof



Warranty:

5 years (Limited 10 Year)

24/7 Commercial Use

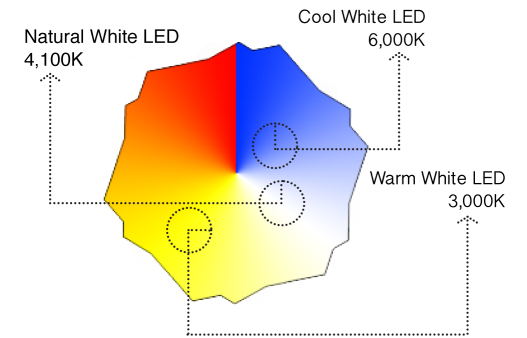

150W Lux data					
LED spotlight			LED streetlight		
Beam Angle 60°		Beam Angle 100°		Beam Angle 125°	
Distance from the light	Illumination	Distance from the light	Illumination	Distance from the light	Illumination
3m	1548	3m	989.4	3m	625.6
6m	482.5	6m	309.25	6m	195.5
8m	272.5	8m	173.75	8m	110
10m	174.25	10m	111.3	10m	70.375
12m	121	12m	76.75	12m	48.75
14m	89	14m	56.75	14m	36
16m	68	16m	43.5	16m	27.5

Electrical Optical Characteristics

Model	Beam Angles	Lumens	Watts	Volts	Chip	Color
EFLT-04-Mahina	45/52/70/85/95/120	ww:1585lm · cw4307lm	50, 60, 70, 80 90, 100, 120	100~240v AC	BridgeLux	3,000 - 7,500k

(Lux): Illuminance is a measurement of the light intensity at any point. The light intensity drops exponentially the further you get from the source.

(Lm): The luminous flux is a measure of the total light output from a source. Ex) a 1 candela light source will produce 1 lumen per square meter at the distance of 1 meter.

EFLT-05 MAHINA

Features:

Street, Walkway, Tunnel, Hi-bay and Landscape Lighting. Please contact us on the details below to find out more about our exciting new "Mahina Series" product range.

Weatherproof

Explosion Proof



Warranty:

5 years (Limited 10 Year)

24/7 Commercial Use

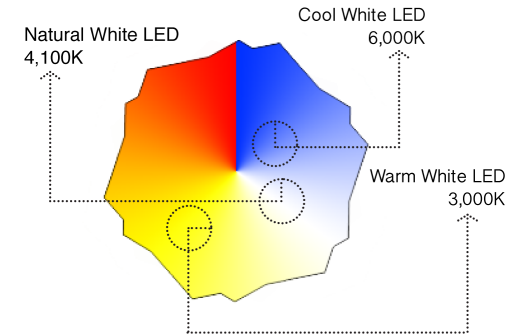

150W Lux data					
LED spotlight			LED streetlight		
Beam Angle 60°		Beam Angle 100°		Beam Angle 125°	
Distance from the light	Illumination	Distance from the light	Illumination	Distance from the light	Illumination
3m	1548	3m	989.4	3m	625.6
6m	482.5	6m	309.25	6m	195.5
8m	272.5	8m	173.75	8m	110
10m	174.25	10m	111.3	10m	70.375
12m	121	12m	76.75	12m	48.75
14m	89	14m	56.75	14m	36
16m	68	16m	43.5	16m	27.5

Electrical Optical Characteristics

Model	Beam Angles	Lumens	Watts	Volts	Chip	Color
EFLT-05-Mahina	45/52/70/85/95/120	ww:1585lm · cw4307lm	50, 60, 70, 80 90, 100, 120	100~240v AC	BridgeLux	3,000 - 7,500k

(Lux): Illuminance is a measurement of the light intensity at any point. The light intensity drops exponentially the further you get from the source.

(Lm): The luminous flux is a measure of the total light output from a source. Ex) a 1 candela light source will produce 1 lumen per square meter at the distance of 1 meter.

EFLT-50 MAHINA

Features:

Street, Walkway, Tunnel, Hi-bay and Landscape Lighting. Please contact us on the details below to find out more about our exciting new "Mahina Series" product range.

Weatherproof

Explosion Proof

Available in Red, Green & Blue



Warranty:

5 years (Limited 10 Year)

24/7 Commercial Use

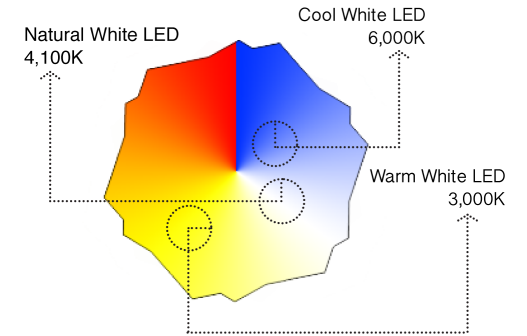

150W Lux data

LED spotlight		LED streetlight			
Beam Angle 60°		Beam Angle 100°		Beam Angle 125°	
Distance from the light	Illumination	Distance from the light	Illumination	Distance from the light	Illumination
3m	1548	3m	989.4	3m	625.6
6m	482.5	6m	309.25	6m	195.5
8m	272.5	8m	173.75	8m	110
10m	174.25	10m	111.3	10m	70.375
12m	121	12m	76.75	12m	48.75
14m	89	14m	56.75	14m	36
16m	68	16m	43.5	16m	27.5

Electrical Optical Characteristics

Model	Beam Angles	Lumens	Watts	Volts	Chip	Color
EFLT-50-Mahina	45/52/70/85/95/120	ww:1585lm · cw4307lm	50, 60, 70, 80 90, 100, 120	100~240v AC	BridgeLux	3,000 - 7,500k

(Lux): Illuminance is a measurement of the light intensity at any point. The light intensity drops exponentially the further you get from the source.

(Lm): The luminous flux is a measure of the total light output from a source. Ex) a 1 candela light source will produce 1 lumen per square meter at the distance of 1 meter.



EFL-**RGB** MAHINA

Features:

Street, Walkway, Tunnel, Hi-bay and Landscape Lighting. Please contact us on the details below to find out more about our exciting new "Mahina Series" product range.

Weatherproof

Explosion Proof



Warranty:

5 years (Limited 10 Year)

24/7 Commercial Use

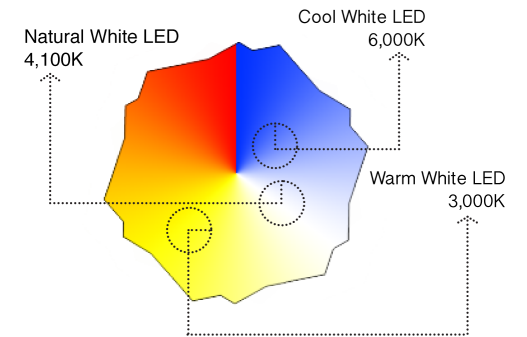

150W Lux data

LED spotlight		LED streetlight			
Beam Angle 60°		Beam Angle 100°		Beam Angle 125°	
Distance from the light	Illumination	Distance from the light	Illumination	Distance from the light	Illumination
3m	1548	3m	989.4	3m	625.6
6m	482.5	6m	309.25	6m	195.5
8m	272.5	8m	173.75	8m	110
10m	174.25	10m	111.3	10m	70.375
12m	121	12m	76.75	12m	48.75
14m	89	14m	56.75	14m	36
16m	68	16m	43.5	16m	27.5

Electrical Optical Characteristics

Model	Beam Angles	Lumens	Watts	Volts	Chip	Color
EFLT- RGB -Mahina	45/52/70/85/95/120	ww:1585lm · cw4307lm	50, 60, 70, 80 90, 100, 120	100~240v AC	BridgeLux	3,000 - 7,500k

(Lux): Illuminance is a measurement of the light intensity at any point. The light intensity drops exponentially the further you get from the source.

(Lm): The luminous flux is a measure of the total light output from a source. Ex) a 1 candela light source will produce 1 lumen per square meter at the distance of 1 meter.

MAHINA-MINI

Features:

Street, Walkway, Tunnel, Hi-bay and Landscape Lighting.. Please contact us on the details below to find out more about our exciting new "Mahina Series" product range.

Weatherproof

Explosion Proof



Warranty:

5 years (Limited 10 Year)

24/7 Commercial Use

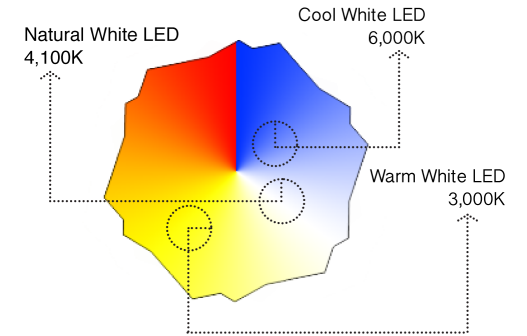

150W Lux data					
LED spotlight				LED streetlight	
Beam Angle 60°		Beam Angle 100°		Beam Angle 125°	
Distance from the light	Illumination	Distance from the light	Illumination	Distance from the light	Illumination
3m	1548	3m	989.4	3m	625.6
6m	482.5	6m	309.25	6m	195.5
8m	272.5	8m	173.75	8m	110
10m	174.25	10m	111.3	10m	70.375
12m	121	12m	76.75	12m	48.75
14m	89	14m	56.75	14m	36
16m	68	16m	43.5	16m	27.5

Electrical Optical Characteristics

Model	Beam Angles	Lumens	Watts	Volts	Chip	Color
Mini-Mahina	90 - 140	ww:540lm · cw:650lm	10 - 15	85~265v AC / 12~48 DC	BridgeLux	3,000-7,500k

(Lux): Illuminance is a measurement of the light intensity at any point. The light intensity drops exponentially the further you get from the source.

(Lm): The luminous flux is a measure of the total light output from a source. Ex) a 1 candela light source will produce 1 lumen per square meter at the distance of 1 meter.